

1 2 3 4 5 6 7 8

REVISIONS			
ISS	ZONE	DESCRIPTION\PER REQUEST\DATE	

業務部

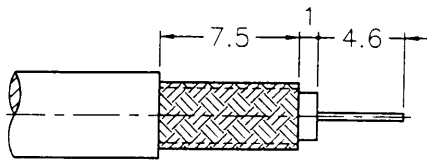

RECOMMENDED  
CABLE STRIPPING DIM'S  
(建議剝線尺寸)  
(STEP 1)

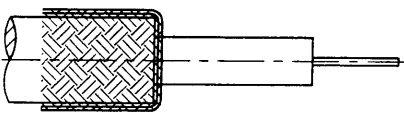

(STEP 2)

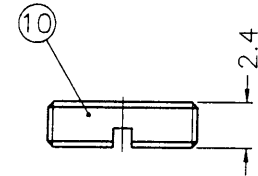
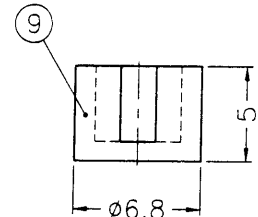
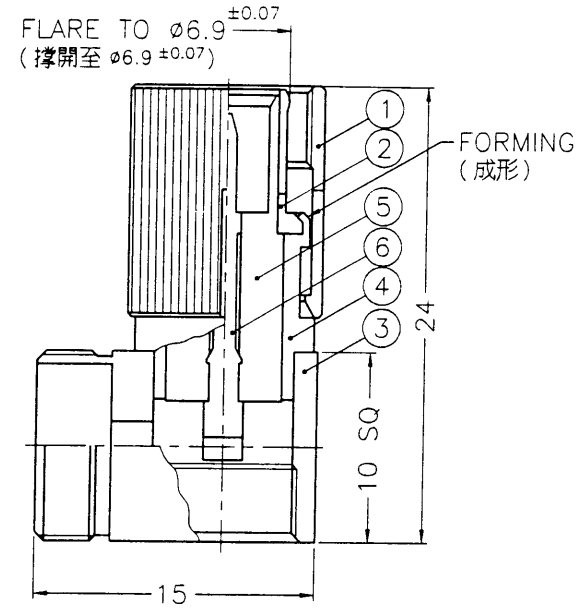
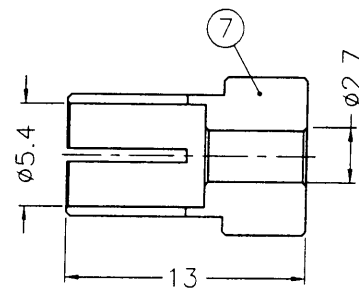
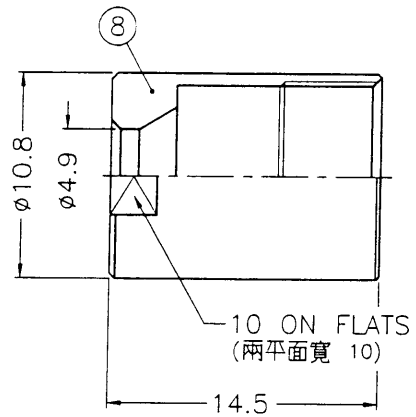

2002.9.05

- NOTES: FINISH (PLATING THICKNESS IN MICRO-INCHES)
1. BRASS PER QQ-B-626
  2. NICKEL PL. 100 MIN. THICK OVER COPPER STRIKE
  3. PHOSPHOR BRONZE PER QQ-B-750
  4. GOLD PL. 3 MIN. THICK OVER NICKEL PL. 100 MIN. THICK OVER COPPER STRIKE
  5. TEFLON MIL-P-19468

10	NUT	NOTE 1	NOTE 2	1	15687061606-5
9	INSULATOR	DELIN	NATURAL	1	15687061606-4
8	NUT	NOTE 1	NOTE 2	1	1566442A1-7-49
7	BRAID CLAMP	NOTE 1	NOTE 2	1	1566442A1-6-54/27
6	CONTACT PIN	NOTE 1	NOTE 4	1	1561112A1-6-B
5	INSULATOR	NOTE 5	NATURAL	1	1561142A1-003-5
4	BODY	NOTE 1	NOTE 2	1	1561112A1-4
3	HOUSING	NOTE 1	NOTE 2	1	1566442A1-2-27
2	OUT CONTACT	NOTE 3	NOTE 4	1	1561121G1-2
1	SHELL	NOTE 1	NOTE 2	1	1561121G1-1-B
NO.	DESCRIPTION	MATERIAL	FINISH	Q'TY	DRAWING NO.

DIMENSIONS ARE IN MILLIMETERS		PART NO.	
UNLESS OTHERWISE SPECIFIED TOLERANCES		APPROVED	DATE
0.5-6 = ±0.2		<i>Jack C</i>	09-05-00'
6-30 = ±0.4		CHECKED	DATE
30-120 = ±0.6		<i>Jacky</i>	09-05-00'
120-315 = ±1		DRAWN	DATE
315-1000 = ±1.6		<i>Toyce</i>	09-05-00'
1000-2000 = ±2.4			

Amphenol - Kai Jack	
TAINAN TAIWAN	
TITLE	1.6/5.6 R/A CLAMP PLUG (FOR 2YCCY CABLE)
DRAWING NO.	KJ-1561142A1-003-N/3GT3G-75
FILE NO.	F:\DWG\156\1142A1\003\75\N3GT3G

F  
E  
D  
C  
B  
A

F  
E  
D  
C  
B  
A

1 2 3 4 5 6 7 8